

Flush mounting for 50 mm (1.96") cutout

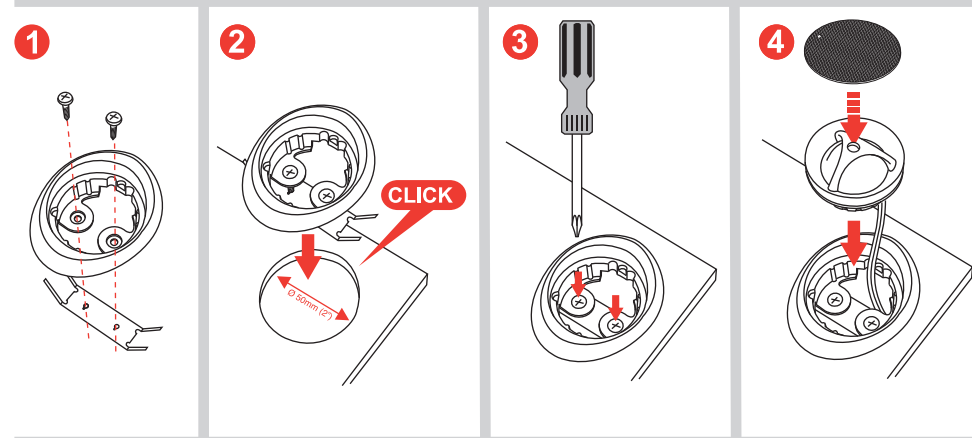

Surface mounting option 2

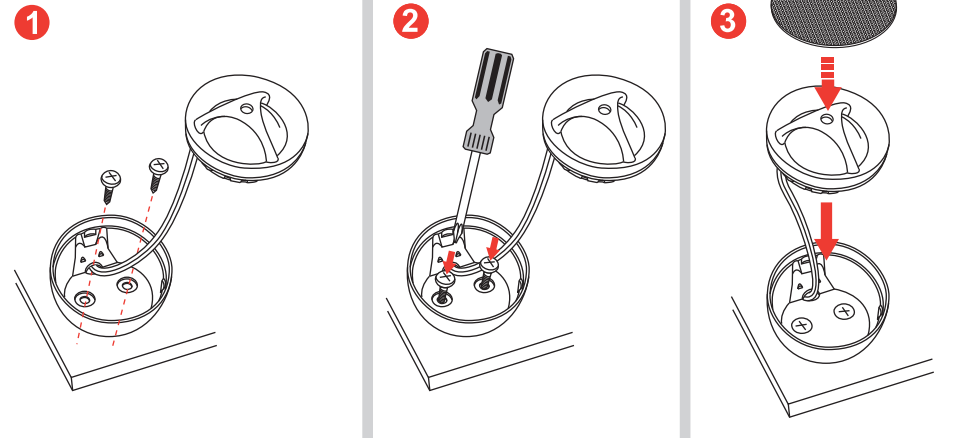

Specifications

2-Way System		Maximo Ultra 5 1/4"	Maximo Ultra 6 1/2"
Nominal Impedance		4 ohm	4 ohm
Power Handling		80W	90W
Max. Transient Power Handling		160W	180W
Sensitivity (2.83V/1M)		89dB	90.5dB
Frequency Response		50-20,000 Hz	50-20,000 Hz
Voice Coil Diameter	Woofer:	25mm(1")	25mm(1")
	Tweeter:	25mm(1")	25mm(1")
Voice Coil Wire		Copper	Copper
Magnet System	Woofer:	High grade ferrite magnet	High grade ferrite magnet
	Tweeter:	Neodymium	Neodymium
Mounting Depth		56mm (2.2")	63mm (2.5")

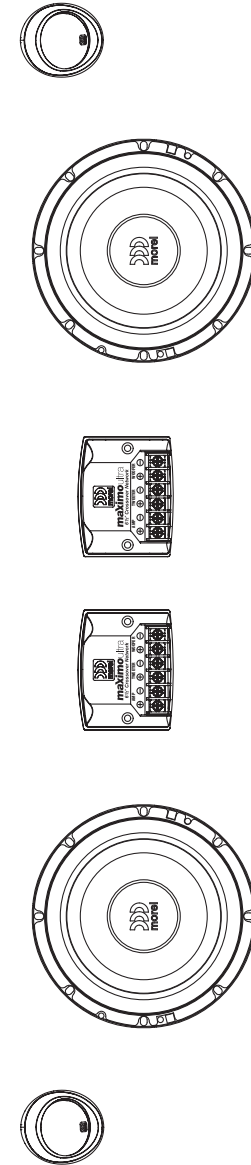

more! **maximo ultra**
Car Audio Component Speaker System

502 6.5 2 Way / 502 5.25 2 Way

Content - Tweeter

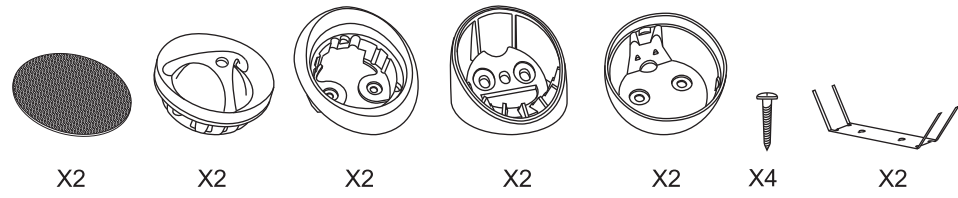

Content - Woofer

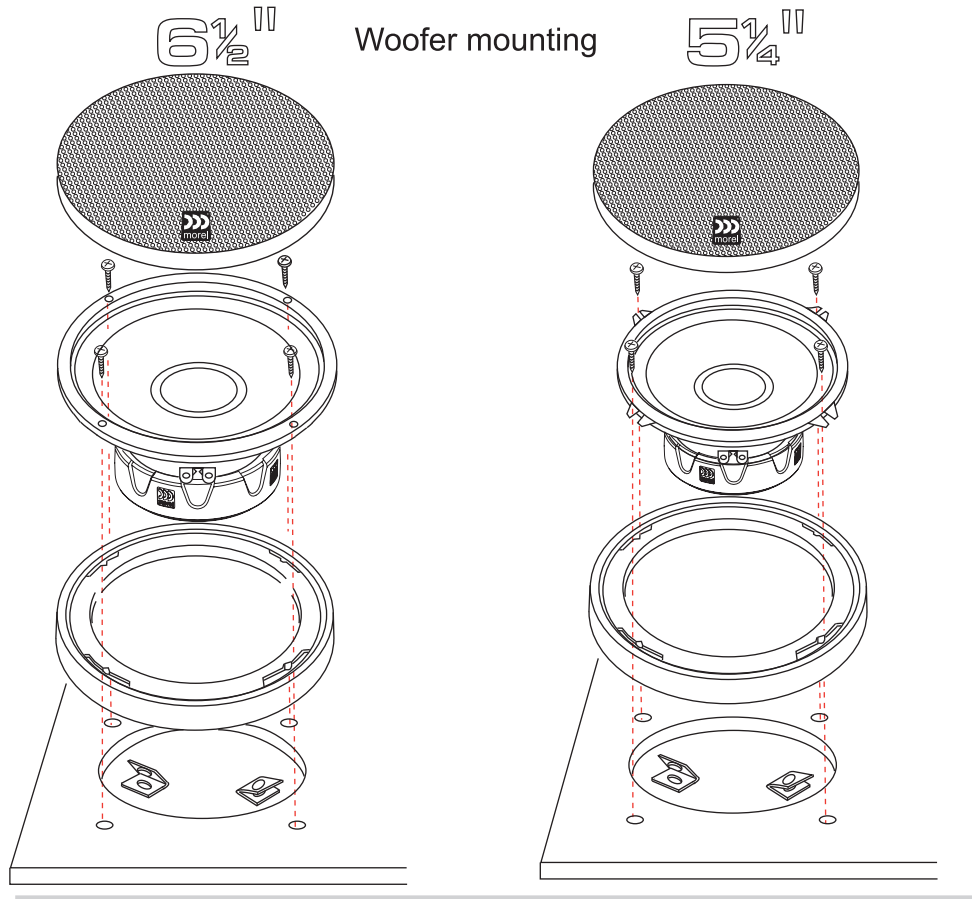
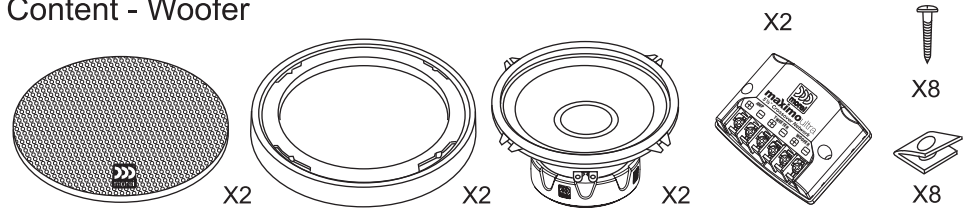

Crossover Connection

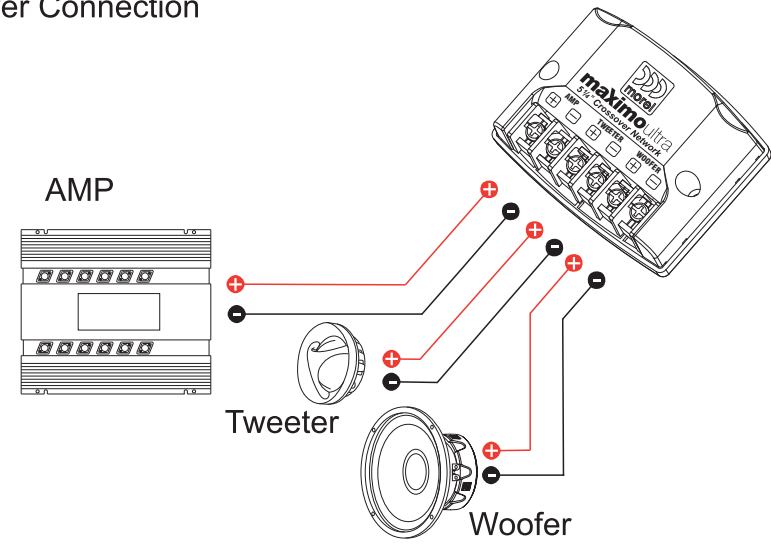

Surface mounting

